



# FLOOR CLEANUP

Best Environmental Practices for Auto Repair and Vehicle Fleet Maintenance • November 1999



## Why keep a dry shop?

The history of wastewater regulations is clear: discharge limits will continue to become more stringent. Minimize the impact of these regulations on your shop by adopting a dry shop goal. A dry shop is a shop that has sealed all its floor drains. Although a 100-percent "dry shop" may not be feasible in your area due to melting snow and ice, the methods and equipment presented in this fact sheet will help you reduce floor wash water volume and contamination. This, in turn, reduces your liabilities, protects the environment and community, and even saves you time and money spent cleaning floors.

## The effects of flushing wash water down storm drains

Water flows untreated from storm drains directly to creeks, streams, lakes, bays, and oceans. If this water is contaminated, it can harm aquatic life; even soapy water can upset aquatic ecosystems. The Clean Water Act makes it illegal to discharge pollutants to surface waters; violators can face imprisonment and fines of up to \$25,000 per day! Storm drain connections to indoor drains or sinks are prohibited in most areas. Storm drains are usually located outside a shop. If you are unsure about the nature of your shop drains, ask the building manager or local sewer authority whether any of the drains are connected to storm water sewers.

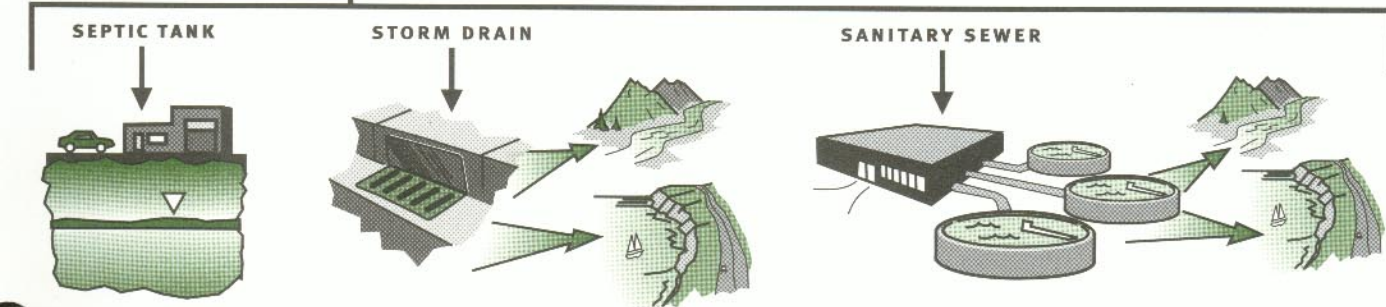

Discharges to septic systems can cause soil, groundwater and drinking water contamination, creating site cleanup liabilities.

Discharges to storm drains flow directly to surface water, causing water pollution and aquatic ecosystems damage.

Metals accumulate in sewage treatment sludge, preventing its beneficial use.

Some contaminants "pass through" and are discharged to lakes, rivers, bays, and oceans.

PELLING CLEAN AND DRY P.2  
LOOK CLEANUP DONE RIGHT P.3  
SPILL PREVENTION EQUIPMENT P.4

## Keeping your shop clean and safe

When used together, the following practices and equipment significantly reduce the amount of water needed to clean shop floors. Minimizing wastewater generation will reduce environmental liability and help your shop stay ahead of tightening regulations.

- Prevent spills from ever reaching the floor. (See back page for equipment.)
- Stop if there's a drop! Never walk away from a spill. If spills are not cleaned up immediately:
  - Workers can slip and fall.
  - Oil, antifreeze, and other spilled material

can mix and be tracked around your shop and into vehicles.

- You will spend more time and money washing the floor.
- Mechanics should carry rags so that small spills can be wiped dry when they occur.
- In case a medium-sized or larger spill occurs, cleanup equipment should be well marked. For example, attach red flags to mop buckets used for spill cleanup so they can be easily located by workers. Keep all spills out of sewer drains
- Sweep your floor with a broom every day to prevent unnecessary dirt and contaminant buildup.
- Never hose down your work area! This practice generates large quantities of contaminated wash water that is discharged to a sewer, or worse, is flushed out of the shop to a storm drain.
- If you use a pressure washer to clean your floors, be sure the wash water is disposed of properly. Even if pressure washing is performed by a contractor, your shop is responsible for proper management of the wash water and can be held liable for its illegal disposal. The best way to avoid this liability and the costs associated with pressure washing is to clean up spills when and where they occur.

### Consider sealing your shop floor

Sealing your shop floor with epoxy or other suitable sealant can be expensive (typical cost for epoxy sealing is \$1.50 to \$2.00 per square foot), but there are several benefits. An epoxy-sealed floor:

- Won't absorb spills as a concrete floor does.
- Makes spill cleanup easier. (You can squeegee small spills into a dustpan and pour liquid into appropriate drum.)
- Requires less time and water to clean.
- Lasts for years and reduces long-term liability for cleanup of a contaminated shop floor and soil below.
- Looks great to customers and workers alike.



Always "Stop if there's a drop!"

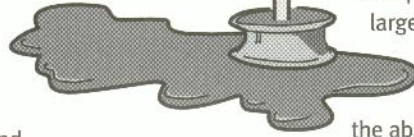

### Use absorbents wisely

#### Pigs, pads, pillows, and mats

- Keep these absorbent devices on-hand to prevent very large spills from spreading.
- After use, wring out the absorbed fluid into the proper drum for recycling or disposal, and reuse the absorbents.
- Spent absorbent devices must be disposed of properly. This involves determining whether the spent absorbent is a hazardous waste.

#### Floor sweep (grease sweep, "kitty litter," rice hull, etc.)

- These absorbents should be used only when the spill can not be cleaned with shop rags or dedicated mops (see next page).
- Restrict the use of these absorbents to cleaning up gasoline, solvent, or other hazardous waste chemical spills. Manage these contaminated absorbents as hazardous waste.
- Use floor sweep until it no longer absorbs fluids. Recycle used floor sweep if possible, or dispose as hazardous waste. Floor sweep can be processed to reclaim and recycle absorbed compounds. Ask your vendor about recycling opportunities for spent floor sweep.

### HYDROPHOBIC MOPS



Hydrophobic mops absorb only oil, not water or anti-freeze. They are available from the following vendors:

CCP in Cleveland, OH (800) 321-1050

Hy-Tec Environmental in Walnut Creek, CA  
(800) 336-4499

*These vendors provided information for this fact sheet. This list is not complete: other vendors may provide similar or identical products and services.*

### customer perception and employee moral

"Cleaning up spills when they occur saves us time and money and keeps the shop looking clean, which my customers and workers both appreciate."

—Larry Moore

Larry's Autoworks  
Mountain View, California

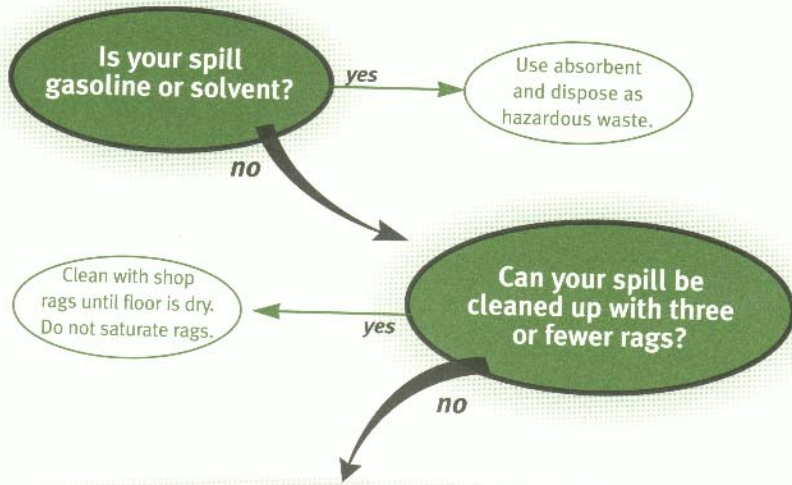

## THE 4-STEP FLOOR CLEANUP METHOD

1

**If oil is present, mop it up first.**

Use a hydrophobic mop only.  
Restrict back-and-forth movement of mop to avoid spreading spill.



Transfer to used oil drum for recycling.

2

**If antifreeze is present, mop it up now.**

Use a dedicated cloth mop only.



Transfer to waste coolant drum for recycling.



3

**Use rags to dry surface.**

Clean with rags until floor is dry.  
Do not saturate.



Send rags to an industrial laundry or properly dispose.

4

**Use a wet mop only if necessary for final cleaning.**

Use a mild, non-caustic detergent.

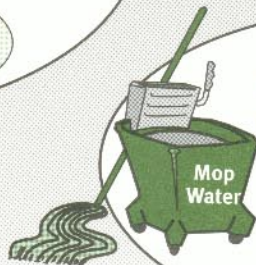

Dump wash water down a sink or toilet (but check with the local sewage agency first).

## Spill prevention equipment

### Water troughs for secondary containment of used oil and waste antifreeze

(available from your local feed store)

- These are the same inexpensive troughs that are used for livestock. Fluids can be pumped out for use or recycling.
- Clearly mark all stored materials.
- Inspect troughs daily for leaks.
- Keep troughs clean and dry.

### Funnel drum covers

Funnel drum covers are available from Hy-Tec Environmental at (800) 336-4499, Spill Cleanup Direct at (800) 356-0783, and Todd Automotive at (800) 467-2750. *(These vendors provided information for this fact sheet. This list is not complete; other vendors may provide similar or identical products and services.)*

- These items minimize spills when transferring liquids from one container to another.
- They also can be used to drain oil filters.

### Bulk, pressurized, overhead fluid delivery

(available from all major motor oil manufacturers)

- Used for oil changes and lube jobs to reduce spills.
- Allows these jobs to be done more quickly.
- The equipment is often provided by the oil manufacturer at no charge.

## You can make a difference!

A shop owner or manager must send a clear message to technicians about how clean the shop should be kept and how spills should be prevented and cleaned up. It's your responsibility to make proper spill prevention and floor cleaning top priorities for every technician.

WATER TROUGH

FUNNEL  
DRUM COVER

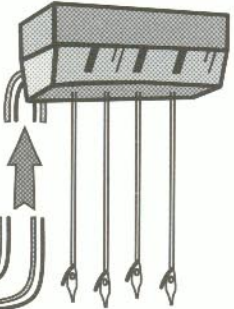
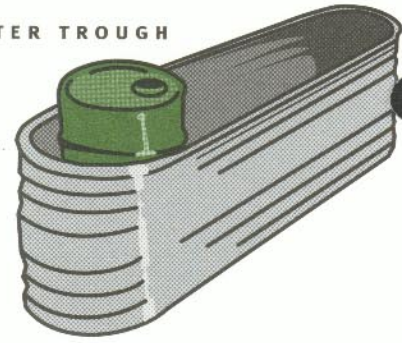
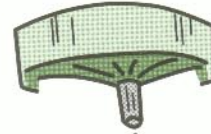

OVERHEAD FLUID  
DELIVERY

### FURTHER SUGGESTIONS

- Regularly maintain your oil/water separator.
- Clearly mark all indoor drains.
- Stencil "No Dumping" near storm drains.
- Change fluids at a location far from sewer connections

Your state or local government environmental agency has more information about compliance and pollution prevention for auto repair shops and fleet maintenance operations in your state or area. Additional fact sheets and information can be found at [www.epa.gov/region09/p2/autofleet](http://www.epa.gov/region09/p2/autofleet). This fact sheet is part of a package of fact sheets entitled either "The Pollution Prevention Tool Kit, Best Environmental Practices for Auto Repair" (publication number EPA-909-E-99-001) or "The Pollution Prevention Tool Kit, Best Environmental Practices for Fleet Maintenance" (publication number EPA-909-E-99-002). To obtain copies of either package, call (800) 490-9198. Accompanying videos, "Profit Through Prevention", are available at the same phone number for either auto repair (number EPA-909-V-99-001) or fleet maintenance (number EPA-909-V-99-002).

